



***Titertek**[®] pipette tips*

Important features and benefits

Titertek[®] premium-quality pipette tips allow your pipette to work the way it was designed— at peak performance and with the best possible accuracy and precision.

To achieve this level of consistency, **Titertek**[®] tips are manufactured from only the best quality raw materials, and are precision-molded using state of the art equipment. Attention to detail and quality control results in perfect fit, perfectly formed flash-free orifices, and non-wettability in the final product. Mold release agents are not used, and special care is taken to ensure the manufacturing environment is kept as clean as possible.

Our goal at ICN is to provide the most complete product line of best-fitting tips available in the marketplace. Tips are available in different types, sizes, colors, lengths, packages, and are offered sterile and non-sterile, filtered and regular, racked and loose (bagged). Our very large selection allows you to choose the best tip for your particular application.

Please take a moment to note the different features available:

Metal-Free All materials used in the manufacture of our tips are free of trace metals. A trace metal certificate is available upon request from our technical service department.

Filter tips Specifically designed for PCR work, RNA/DNA solutions, and for working with radioactive labeled samples or infectious materials, these pipette tips contain a small micron high-density polyethylene filter which prevents airborne contaminants from coming into contact with the tip cone and internal parts of your pipette. The filters do not use sealing additives or coatings ensuring that no contamination can occur. All filter tips are tested and certified by an independent laboratory to be RNase, DNase, and pyrogen-free. A Certificate of Analysis is available on request from our technical service department. All filter tips are pre-sterilized and shrink-wrapped.

Sterilization Sterilized products are processed by Gamma-Cobalt 60 irradiation in accordance with AAMI guidelines. A Certificate of Irradiation is available upon request.

Autoclaving All tips (except filter tips) and racks are autoclavable - process at 120°C at 15 pounds of pressure for 15 minutes. (All filter tips are supplied pre-sterilized.)

Recyclability Polypropylene tips and racks can be easily recycled; contact your local waste disposal company for more information on how to be environmentally friendly!

Low adhesion The premium-quality virgin polypropylene and advanced manufacturing techniques used mean that **Titertek**[®] tips have a very low coefficient of friction and are hydrophobic (non-wettable) in nature; this means you may not need to purchase special siliconized “low adhesion” tips offered elsewhere. **Titertek**[®] tips give superior results, optimal yield, and minimal sample loss compared to inferior pipette tips.

Available Tips:

Filter Tips Specifically designed for PCR work, RNA/DNA solutions, and for working with radioactive labeled samples or infectious materials, these pipette tips contain a small micron high-density polyethylene filter which prevents airborne contaminants from coming into contact with the tip cone and internal parts of your pipette. The filters do not use sealing additives or coatings, reducing the possibility of contamination. Filter tips are ideal for PCR and other amplification methods, or for any work where aerosol (vapor) contamination may occur. Tested and certified by an independent laboratory to be RNase-free, DNase-free, pyrogen-free, and metal-free. **Titertek®** Filter tips cannot be autoclaved, but are provided pre-sterilized by gamma irradiation. Available in racks or individually wrapped in bags of 100.

Gel-Loading Tips The long narrow ends and small orifices of these tips are useful for a wide variety of sample loading applications such as protein separations, nucleic acid sequencing, and other gel loading applications.

Graduated Tips Some of our popular tips are available in graduated versions, which have reference lines to allow a quick check of your pipetting procedure by indicating nominal liquid volume in the tip.

Extra-Long Tips Several popular tips are available in extra-long sizes to allow the pipette to retrieve samples from deep narrow vessels, test tubes, etc., or whenever you need extra reach for your particular application.

Thin-wall orifice Tips These tips can improve pipetting at very small volumes and reduce liquid retention compared to standard tips.

Wide orifice Tips These tips can help when pipetting small volumes of viscous materials. Eliminates mechanical shearing of fragile cells. Ideal for pipetting fragile cell suspensions and macromolecules like genomic DNA.

Beveled orifice Tips The beveled end is another method of reducing liquid retention for some applications and is preferred by many customers.

Robotic Tips Manufactured of carbon black-conductive polypropylene for liquid-level sensing, especially for use with robotic liquid handling systems. This highly conductive material is necessary to detect the presence or absence of sufficient liquid, in order to avoid short sampling and excessive submersion of the tip during aspiration. Racked tips are available in a special rigid rack with individual compartments for each tip to prevent cross-contamination. (Robotic tips are also available in natural polypropylene, and in heavy-duty racks, for automated liquid handling systems.) We offer a wide selection of robotic tips, including filter tips, ranging in volumes from 10 µl to 1000 µl for use with several systems.

Ultra Micro Tips Several tips are available for accurate pipetting at very small volumes, including a micro gel-loading tip. These tips also feature convenient reference lines.

Tip Bands Unique - 4 tips joined with a band, for use with **Titertek®** and **Finnpipette®** multichannel pipettes.

Multistepper Tips Custom-made to fit the Titertek® and Finnpipette® Multistepper.

Other Information:

Bulk (bagged) Bulk-packaged tips are packed loose in heavy-duty poly bags with a zipper closure, and can be an economical choice for refilling empty racks. Most types are packaged 1000 per bag and are supplied non-sterile.

Racked Tips The standard 96-tip rack accommodates single and multi-channel pipettes. Precise hole spacing in the 8x12 format offers perfect alignment with 96-well microtitration plates. Supplied with a lift-off cover and a sonic-welded base. The entire rack is autoclavable and recyclable. Some of our racked tips are packaged in racks of 100, and extra-long and gel-loading tips are packaged in racks of 204; refer to the product listing for this information.
All racked tips are also available pre-sterilized.

Heavy-Duty Racks Our heavy-duty rack features 96 individual inner compartments, which keep tips separated from each other in the rack to reduce the possibility of cross-contamination. The inner walls of these compartments provide stiffness and extra stability, which makes these racks ideal for use with automated liquid handling systems (see Robotic tips) and also makes them ideal for use with multichannel pipettes. Packaging is the same as our standard 96-tip rack, and the entire unit is autoclavable and recyclable.

Stack Rack Our stack-rack system utilizes the same rack, base, and lift-off cover as our 100 and 200-tip racks. These systems offer the convenience of racked tips at a more economical price. These racks are nested 5 high, with a cover on top, and the entire unit is shrink-wrapped.

Volume Range Tips are listed with a maximum volume range. This corresponds to the maximum volume of the instrument with which the tip is designed to be used. In actuality, many tips have a greater capacity than what is listed.

Additional Information on Filter Tips:

Titertek® filter tips are especially useful in preventing contamination problems. We strongly recommend their use for the following types of liquids - of course you may use filter tips for other purposes and choose them any time to minimize the chances of contamination.

- 1) INORGANIC ACIDS and/or ALKALIS:** in case of contamination, rinse your pipette's tip cones with distilled water. Filter tips are important since aerosols can enter the lower part of the pipette and affect its performance.
- 2) POTENTIALLY INFECTIOUS LIQUIDS:** in case of contamination, insert your pipette's tips cones and ejector in a 70% ethyl alcohol solution overnight. Follow with a rinse in distilled water.
- 3) CELL CULTURES:** filter tips can help ensure sterility. In case of contamination, see #2 instructions.
- 4) ORGANIC SOLVENTS:** density difference may require re-calibration of your pipette in order to ensure accuracy.
- 5) RADIOACTIVE:** filter tips can help avoid contamination of your pipette. Use ICN's Dekasol® cleaning solution to clean and decontaminate laboratory equipment. (ICN Cat. no. 808026)
- 6) PROTEINS:** filter tips can help avoid contamination. If needed, clean affected parts with laboratory detergent.

*ICN offers 7X® Cleaning Solution for safe and effective general cleaning of laboratory equipment.
(ICN Cat. No. 7667094, or 7667194 for phosphate-free formulation)*

Titertek[®] Pipette Tips

Standard Yellow tips begin on page 9

Titertek[®] Superpack-96[™]

For Titertek[®] & Labsystems Finnpiquette[®]



Volume: 5-300 μ l

Also for use with: Biohit Proline[®], Costar[®], Jencons Sealpette[®],

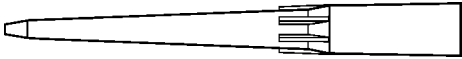
Labpette[™], Nichiryo, Oxford-Benchmate[®], Pipetman[®] P-200

Regular	Catalog No.	Color	Package Type	Quantity	Price
	77987C2	Natural	Bulk	1000	\$29.20
	77987H2	Natural	Racked	10 x 96	55.50
	77988H2	Natural	Sterile Racked	10 x 96	61.40

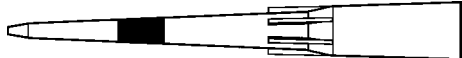

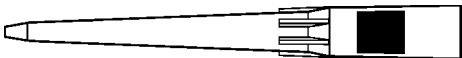
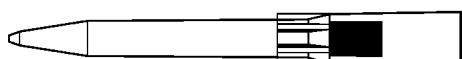
FILTERED — special 300 μ l high-capacity type available

	7799105 - 10 μl	Natural	Ind. Wrapped, Sterile	100	19.15
	77991H2 - 10 μl	Natural	Sterile Racked	10 x 96	131.90
	7799205 - 50 μl	Natural	Ind. Wrapped, Sterile	100	19.15
	77992H2 - 50 μl	Natural	Sterile Racked	10 x 96	131.90
	7799305 - 250 μl	Natural	Ind. Wrapped, Sterile	100	19.15
	77993H2 - 250 μl	Natural	Sterile Racked	10 x 96	131.90
	7799405 - 300 μl	Natural	Ind. Wrapped, Sterile	100	19.15
	77994H2 - 300 μl	Natural	Sterile Racked	10 x 96	131.90

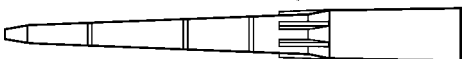
Graduated at 10, 50, 100, & 200 μ l

	GR77987C2	Natural	Bulk	1000	28.00
	GR77987H2	Natural	Racked	10 x 96	52.00
	GR77988C2	Natural	Sterile Racked	10 x 96	57.00
With heavy-duty rack	HDGR77987H2	Natural	HD Racked	10 x 96	57.00
	HDGR77988H2	Natural	Sterile HD Racked	10 x 96	62.00

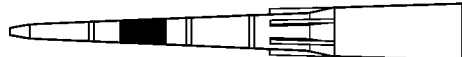
Graduated and FILTERED

	GR7799105 -10 μl	Natural	Ind. Wrapped, Sterile	100	19.15
	GR77991H2 -10 μl	Natural	Sterile Racked	10 x 96	131.90
	GR7799205-100 μl	Natural	Ind. Wrapped, Sterile	100	19.15
	GR77992H2-100 μl	Natural	Sterile Racked	10 x 96	131.90
	GR7799305-200 μl	Natural	Ind. Wrapped, Sterile	100	19.15
	GR77993H2-200 μl	Natural	Sterile Racked	10 x 96	131.90

Note: Between the graduated and non-graduated versions, this size tip is available in six different filter capacities: 10 μ l, 50 μ l, 100 μ l, 200 μ l, 250 μ l, and 300 μ l.

Multistepper Tip -specifically for the Titertek® / Labsystems 8-channel Multistepper pipette
(ICN's Multistepper pipette catalog number is A7794200, also fits # 7794200)

Volume: 5-1250 µl

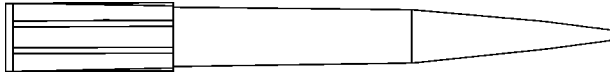

<u>Catalog No.</u>	<u>Color</u>	<u>Package Type</u>	<u>Quantity</u>	<u>Price</u>
77943C2	Natural	Bulk	1000	\$55.50
77943H2	Natural	Racked	10 x 96	68.65
77944H2	Natural	Sterile Racked	10 x 96	74.55

Finntip-50® - specifically for the Titertek® / Labsystems 16-channel Finnpipette-384®

ICN's Finnpipette® catalog number is A7777000)

Volume: 5-50 µl

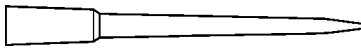

<u>Catalog No.</u>	<u>Color</u>	<u>Package Type</u>	<u>Quantity</u>	<u>Price</u>
A77771C2	Natural	Bulk	1000	79.95
A77771C4	Natural	Racked	1 x 384	82.00
A77772C4	Natural	Racked	1 x 384	89.00

Stepper Tips - specifically for the Titertek® / Labsystems Stepper pipette

(ICN's Stepper pipette catalog number is A7773500)



NSAdapter
STAdapter

<u>Catalog No.</u>	<u>Color</u>	<u>Package Type</u>	<u>Quantity</u>	<u>Price</u>
A7774005 - 0.5 µl	Natural	Box	100	137.00
A7774104- 0.5 µl	Natural	Box,sterile	50	92.00
A7774205 - 1.25 µl	Natural	Box	100	137.00
A7774304 - 1.25 µl	Natural	Box, sterile	50	92.00
A7774405 - 2.5 µl	Natural	Box	100	137.00
A7774504 - 2.5 µl	Natural	Box, sterile	50	92.00
A7774604 - 5.0 µl	Natural	Box	50	69.75
A77747A7 - 5.0 µl	Natural	Box, sterile	25	45.00
A7774804 - 12.5 µl	Natural	Box	50	69.75
A77749A7 - 12.5 µl	Natural	Box, sterile	25	45.00
A7775003 - 25 µl	Natural	Box	20	29.25
A7775102 - 25 µl	Natural	Box, sterile	10	22.50
A7775202 - 50 µl	Natural	Box	10	20.25
A7775302 - 50 µl	Natural	Box, sterile	10	22.50
A7773601	Natural	each	each	inquire
A7773701	Natural	each	each	inquire

Tip Bands

max. capacity: 340 µl

4 tips per band

fits Titertek®, Finnpipette™, and other multichannel pipettes

<u>Catalog No.</u>	<u>Color</u>	<u>Package Type</u>	<u>Quantity</u>	<u>Price</u>
A7789605	Natural	Box, non-sterile	100 bands	44.65

Titertek-Plus® Superpack-96™ Volume 5-250 µl

for Titertek-Plus® and Socorex Also for use with: Biohit Proline®, Eppendorf® Reference & Research,

Finnpipette®, Labpette™, Nichiryo, Rainin EDP2™, Oxford-Benchmate®, Volac

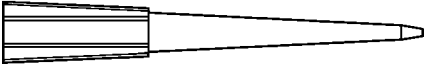
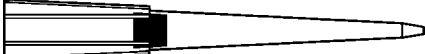
	<u>Catalog No.</u>	<u>Color</u>	<u>Package Type</u>	<u>Quantity</u>	<u>Price</u>
Regular 	79987C2	Natural	Bulk	1000	\$31.30
	79987H2	Natural	Racked	10 x 96	57.75
	79988H2	Natural	Sterile Racked	10 x 96	65.00
	79987ST	Natural	200/rack	5 x 200	34.00
	Stack Rack				
Heavy-Duty Rack	HD79987H2	Natural	HD Racked	10 x 96	62.00
	HD79988H2	Natural	Sterile HD Racked	10 x 96	67.00
FILTERED 	7999805 - 100 µl	Natural	Ind. Wrapped, Sterile	100	17.75
	79998H2 - 100 µl	Natural	Sterile Racked	10 x 96	131.90

Microcapillary Gel-Loading Tip Volume 1-200 µl

for Pipetman®

Also for use with: Biohit Proline®, Costar®, Eppendorf®, Finnpipette®, Labpette™, Nichiryo,

Titertek® Digital, Jencons Sealpette®, Socorex, Oxford-Benchmate®, Rainin EDP2™

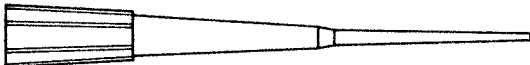
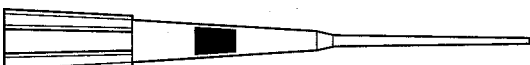
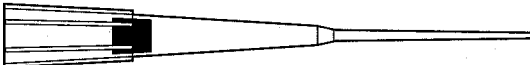
	<u>Catalog No.</u>	<u>Color</u>	<u>Package Type</u>	<u>Quantity</u>	<u>Price</u>
Regular 	79746C2	Natural	Bulk	1000	38.55
	79746G4	Natural	Racked	10 x 204	59.65
	79747G4	Natural	Sterile Racked	10 x 204	68.75
FILTERED 	7987105 - 20 µl	Natural	Ind. Wrapped, Sterile	100	18.15
	79871G4 - 20 µl	Natural	Sterile Racked	10 x 204	128.15
	7987205-100 µl	Natural	Ind. Wrapped, Sterile	100	18.15
	79872G4-100 µl	Natural	Sterile Racked	10 x 204	128.15

Filter tips are specifically designed to prevent airborne contaminants from coming into contact with the barrel and internal parts of your pipette. In addition, they prevent liquid bypass should accidental over-pipetting occur, yet allow for complete uncontaminated sample retrieval - which can be very important when working with small and precious amounts of samples.

All Titertek® Filter tips are pre-sterilized by gamma irradiation and are certified RNase, DNase, and pyrogen-free; also trace metal-free. This mark assures you that these pipette tips are of the highest possible quality.



Ultra-Micro Tip with 2.5 µl reference mark Volume 0.1-10 µl

For Pipetman®

Also for use with: Biohit Proline®, Jencons Sealpette®, Eppendorf® Reference & Research, Labpette™, Nichiryo, Rainin, Oxford-Benchmate®

Regular

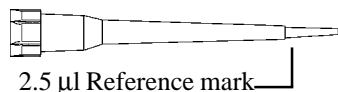

2.5 µl Reference mark

Catalog No.	Color	Package Type	Quantity	Price
79760C2	Natural	Bulk	1000	\$19.75
79760H2*	Natural	Racked	10 x 96	40.00
79761H2*	Natural	Sterile Racked	10 x 96	46.50

FILTERED

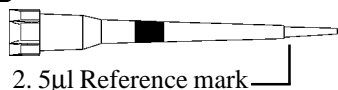

2.5 µl Reference mark

7991105	Natural	Ind. Wrapped, Sterile	100	16.50
79911H2*	Natural	Sterile Racked	10 x 96	128.15

*The rack for this product includes a hinged cover.

Ultra-Micro Tip with 2.0 µl reference mark Volume 0.1-10 µl

For Pipetman®

Also for use with: Biohit Proline®, Jencons Sealpette®, Eppendorf® Reference & Research, Labpette™, Nichiryo, Rainin EDP-2™, Oxford-Benchmate®

Regular

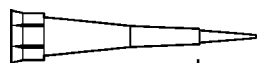

2.0 µl Reference mark

Catalog No.	Color	Package Type	Quantity	Price
79770C2	Natural	Bulk	1000	19.75
79770H2	Natural	Racked	10 x 96	40.00
79771H2	Natural	Sterile Racked	10 x 96	44.25

Heavy-Duty Rack

HD79770H2	Natural	HD Racked	10 x 96	46.00
HD79771H2	Natural	Sterile HD Racked	10 x 96	51.00

FILTERED



2.0 µl Reference mark

7993105	Natural	Ind. Wrapped, Sterile	100	16.50
79931H2	Natural	Sterile Racked	10 x 96	121.50

Black Conductive



BK79770C2	Black	Bulk	1000	32.75
BK79770H2*	Black	Racked	10 x 96	53.00
BK79771H2*	Black	Sterile Racked	10 x 96	57.25

* Available in optional heavy-duty rack - use HD prefix, add \$5 to price

“Ultra-Micro” Microcapillary Gel-Loading Tip Volume 0.1-10 µl

For Pipetman®

Also for use with: Biohit Proline®, Jencons Sealpette®, Labpette™, Nichiryo, Eppendorf® Reference & Research, Oxford-Benchmate®

Regular

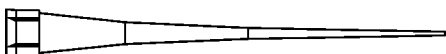

Catalog No.	Color	Package Type	Quantity	Price
79766C2	Natural	Bulk	1000	39.60
79766G4	Natural	Racked	10 x 204	57.50
79767G4	Natural	Sterile Racked	10 x 204	62.25

FILTERED

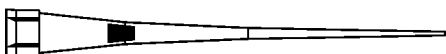



7992105	Natural	Ind. Wrapped, Sterile	100	18.15
79921G4	Natural	Sterile Racked	10 x 204	128.15

Ultra-Micro “Nano” Tip with 2.5 µl reference mark Volume 0.1-10 µl

For Eppendorf® Reference & Research

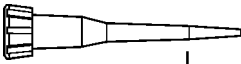

Also for use with: Biohit Proline®, Jencons Sealpette®, Labpette™, Nichiryo, Oxford-Benchmate®, Pipetman®

		<u>Catalog No.</u>	<u>Color</u>	<u>Package Type</u>	<u>Quantity</u>	<u>Price</u>
Regular		79750C2	Natural	Bulk	1000	\$19.75
		79750H2	Natural	Racked	10 x 96	40.00
		79751H2	Natural	Sterile Racked	10 x 96	44.25
	Heavy-Duty Rack	HD79750H2	Natural	HD Racked	10 x 96	46.00
		HD79751H2	Natural	Sterile HD Racked	10 x 96	51.00
FILTERED		7990105-5 µl	Natural	Ind. Wrapped, Sterile	100	16.50
		79901H2-5 µl	Natural	Sterile Racked	10 x 96	121.50

Ultra-Micro Tip Volume 0.5-10 µl

For Eppendorf®

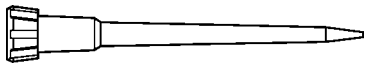
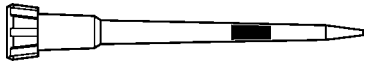
Also for use with: Titertek-Plus®, Socorex, Labpette™, Nichiryo, Oxford-Benchmate®

		<u>Catalog No.</u>	<u>Color</u>	<u>Package Type</u>	<u>Quantity</u>	<u>Price</u>
Regular		79741C2	Natural	Bulk	1000	21.40
		79741G8	Natural	Racked	10 x 100	41.00
		79743G8	Natural	Sterile Racked	10 x 100	45.60
FILTERED		7994105-10 µl	Natural	Ind. Wrapped, Sterile	100	16.50
		79941G8-10 µl	Natural	Sterile Racked	10 x 100	121.50
FILTERED		7994205-20 µl	Natural	Ind. Wrapped, Sterile	100	16.50
		79942G8-20 µl	Natural	Sterile Racked	10 x 100	121.50
Black Conductive		BK79741C2	Black	Bulk	1000	32.75
		BK79741G8*	Black	Racked	10 x 100	50.75
		BK79743G8*	Black	Sterile Racked	10 x 100	55.00

*Available in optional heavy-duty rack - add HD prefix and \$5 to price.

Ultra-Micro Microcapillary Tip Volume 0.5-10 µl

For Eppendorf®

Also for use with: Titertek-Plus®, Socorex, Nichiryo, Oxford-Benchmate®

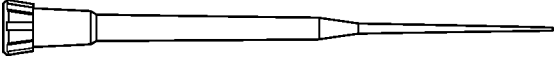
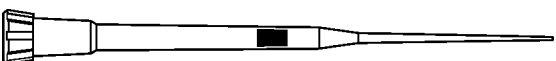
		<u>Catalog No.</u>	<u>Color</u>	<u>Package Type</u>	<u>Quantity</u>	<u>Price</u>
Regular		79780C2	Natural	Bulk	1000	21.40
		79780G4	Natural	Racked	10 x 204	41.00
		79781G4	Natural	Sterile Racked	10 x 204	45.60
FILTERED		7995105	Natural	Ind. Wrapped, Sterile	100	16.50
		79951G4	Natural	Sterile Racked	10 x 204	121.50

Standard YELLOW 200 µl Tips

Standard tips are for use with Pipetman® & Eppendorf® pipettes,

also for use with: Costar® Onepette, 8 & 12 Pette®, Finnpiquette®, Titertek-Plus®, Labpette™,

MLA®, Nichiryo, Oxford-Benchmate®, Rainin EDP2™, Socorex, Volac

STANDARD (YELLOW) Volume 1-200 µl

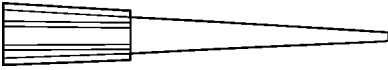
	<u>Catalog No.</u>	<u>Color</u>	<u>Package Type</u>	<u>Quantity</u>	<u>Price</u>
Regular 	79100C2	Yellow	Bulk	1000	\$19.00
	79100H2	Yellow	Racked	10 x 96	36.25
	79101H2	Yellow	Sterile Racked	10 x 96	40.25
	79100ST	Yellow	200/rack	5 x 200	30.50
StackRack					
Heavy-Duty Rack	HD79100H2	Yellow	HD Racked	10 x 96	41.50
	HD79101H2	Yellow	Sterile HD Racked	10 x 96	46.00
Q-stack^s	79100Q5	Yellow	Racked	10 x 96	29.80
	79101Q5	Yellow	Sterile Racked	5 x 96	17.35

Black Conductive



BK79100C2	Black	Bulk	1000	32.75
BK79100H2*	Black	Racked	10 x 96	50.75
BK79101H2*	Black	Sterile Racked	10 x 96	55.00

*Available in optional heavy-duty rack, add HD prefix and \$5 to price

STANDARD (YELLOW) - BEVELED TIP Volume 1-200 µl

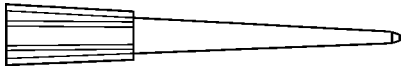
	<u>Catalog No.</u>	<u>Color</u>	<u>Package Type</u>	<u>Quantity</u>	<u>Price</u>
Regular 	79110C2	Yellow	Bulk	1000	19.00
	79110H2	Yellow	Racked	10 x 96	36.25
	79111H2	Yellow	Sterile Racked	10 x 96	40.25
	79110ST	Yellow	200/rack	5 x 200	30.50
StackRack					
Heavy-Duty Rack	HD79110H2	Yellow	HD Racked	10 x 96	41.50
	HD79111H2	Yellow	Sterile HD Racked	10 x 96	46.00
Q-stack^s	79110Q5	Yellow	Racked	10 x 96	29.80
	79111Q5	Yellow	Sterile Racked	5 x 96	17.35

FILTERED — four volume capacities available

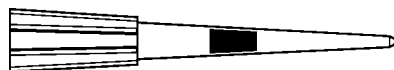

7981105 - 20 µl	Natural	Ind. Wrapped, Sterile	100	16.50
79811H2 - 20 µl	Natural	Sterile Racked	10 x 96	121.50



7981205 - 50 µl	Natural	Ind. Wrapped, Sterile	100	16.50
79812H2 - 50 µl	Natural	Sterile Racked	10 x 96	121.50

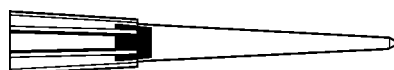

7981305-100 µl	Natural	Ind. Wrapped, Sterile	100	16.50
79813H2-100 µl	Natural	Sterile Racked	10 x 96	121.50

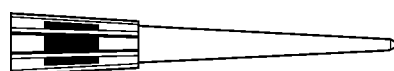

7981405-150 µl	Natural	Ind. Wrapped, Sterile	100	16.50
79814H2-150 µl	Natural	Sterile Racked	10 x 96	121.50

Standard 200 µl tips (continued) for use with Pipetman® & Eppendorf® pipettes,

also for use with: Costar® Onepette, 8 & 12 Pette®, Finnpipette®, Titertek-Plus®, Labpette™, MLA®, Nichiryo, Oxford-Benchmate®, Rainin EDP2®, Socorex, Volac

STANDARD (YELLOW) - BEVELED & GRADUATED Volume 1-200 µl

Graduated at 10, 50, and 100 µl for easy reference

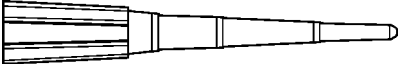
	Catalog No.	Color	Package Type	Quantity	Price
	GR79110C2	Yellow	Bulk	1000	\$19.00
	GR79110H2	Yellow	Racked	10 x 96	36.25
	GR79111H2	Yellow	Sterile Racked	10 x 96	40.25
	GR79110ST	Yellow	200/rack	5 x 200	30.50
StackRack					
Heavy-Duty Rack	HDGR79110H2	Yellow	HD Racked	10 x 96	43.00
	HDGR79111H2	Yellow	Sterile HD Racked	10 x 96	48.00
Q-stack^s	GR79110Q5	Yellow	Racked	10 x 96	29.80
	GR79111Q5	Yellow	Sterile Racked	5 x 96	17.35

STANDARD (THIN-WALL ORIFICE) 200 µl size, capacity 1-250 µl

Reduces liquid retention and improves operation at small volumes

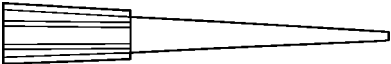
	Catalog No.	Color	Package Type	Quantity	Price
	79120C2	Natural	Bulk	1000	19.00
	79120H2	Natural	Racked	10 x 96	36.25
	79121H2	Natural	Sterile Racked	10 x 96	40.25
Heavy-Duty Rack	HD79120H2	Natural	HD Racked	10 x 96	41.50
	HD79121H2	Natural	Sterile HD Racked	10 x 96	46.00

STANDARD (LARGE ORIFICE) Volume 1-200 µl

Accurate pipetting of high-viscosity liquids

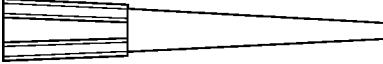
Regular	Catalog No.	Color	Package Type	Quantity	Price
	79140C2	Natural	Bulk	1000	19.00
	79140H2	Natural	Racked	10 x 96	36.25
	79141H2	Natural	Sterile Racked	10 x 96	40.25
	79140ST	Natural	200/rack	5 x 200	30.50
StackRack					
Heavy-Duty Rack	HD79140H2	Natural	HD Racked	10 x 96	41.50
	HD79141H2	Natural	Sterile HD Racked	10 x 96	46.00

FILTERED

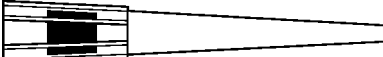
	7984105	Natural	Ind. Wrapped, Sterile	100	18.15
	79841H2	Natural	Sterile Racked	10 x 96	128.15

Standard 200 µl tips (continued) for use with Pipetman® & Eppendorf® pipettes,

also for use with: Costar® Onepette, 8 & 12 Pette®, Finnpiquette®, Titertek-Plus®, Labpette™, MLA®, Nichiryo· Oxford-Benchmate®, Rainin EDP2™, Socorex, Volac

STANDARD SIZE (EXTRA-LONG) Volume 1-200 µl

3 1/2 inches long for extra reach and maximum sampling!

Regular

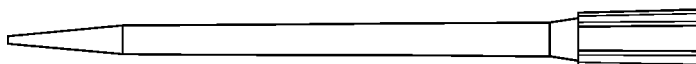

<u>Catalog No.</u>	<u>Color</u>	<u>Package Type</u>	<u>Quantity</u>	<u>Price</u>
79130C2	Natural	Bulk	1000	\$28.00
79130G4	Natural	Racked	8 x 204	101.50
79131G4	Natural	Sterile Racked	8 x 204	108.50

FILTERED

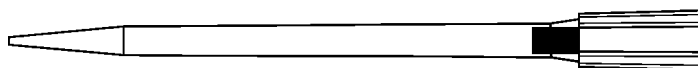

<u>Catalog No.</u>	<u>Color</u>	<u>Package Type</u>	<u>Quantity</u>	<u>Price</u>
7980505	Natural	Ind. Wrapped, Sterile	100	18.50
79805G4	Natural	Sterile Racked	8 x 204	215.00

Standard BLUE 1000 µl Tips



for use with Pipetman® & Eppendorf® pipettes,

also for use with (but not limited to): Costar® Onevette, Finnpiquette®, Labpette™, Nichiryo, Oxford-Benchmate®, Rainin EDP2™, Volac

STANDARD (BLUE)

Volume 101-1000 µl

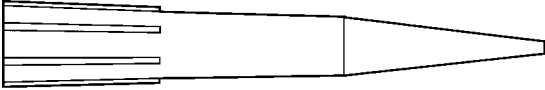
FILTERED standard-size blue tips are available in the "extra long" size below

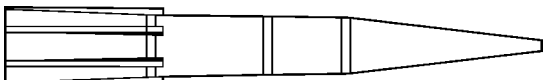
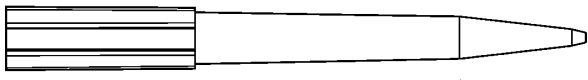
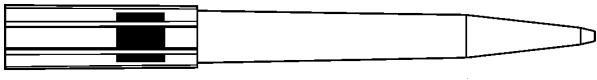
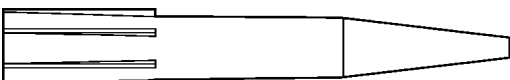
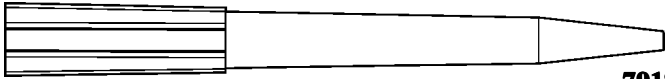
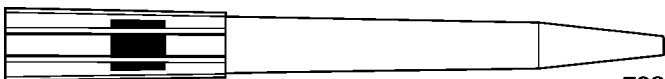
Regular	Catalog No.	Color	Package	Quantity	Price
 <p style="text-align: right;">StackRack</p>	79150C2	Blue	Bulk	1000	\$22.35
	79150G8	Blue	Racked	10 x 100	45.35
	79151G8	Blue	Sterile Racked	10 x 100	50.75
	79150ST	Blue	100/Rack	10 x 100	37.50
Black Conductive					
	HDBK79150G8	Black	HD Racked	10 x 100	78.00
	HDBK79151G8	Black	Sterile HD Racked	10 x 100	86.50
Graduated					
 <p style="text-align: right;">StackRack</p>	GR79150C2	Blue	Bulk	1000	23.50
	GR79150G8	Blue	Racked	10 x 100	46.50
	GR79151G8	Blue	Sterile Racked	10 x 100	51.75
	GR79150ST	Blue	100/Rack	10 x 100	38.50
Extra-Long (for maximum reach)					
 <p style="text-align: right;">StackRack</p>	79160C2	Blue	Bulk	1000	23.00
	79160G8	Blue	Racked	10 x 100	46.00
	79161G8	Blue	Sterile Racked	10 x 100	51.00
	79160ST	Blue	100/Rack	10 x 100	38.00
FILTERED, Extra long for full 1000 µl capacity					
	7975405	Natural	Ind. Wrapped, Sterile	1000	19.15
	79754G8	Natural	Sterile Racked	10 x 100	137.60
Large Orifice					
 <p style="text-align: right;">StackRack</p>	79170C2	Natural	Bulk	1000	22.35
	79170G8	Natural	Racked	10 x 100	45.35
	79171G8	Natural	Sterile Racked	10 x 100	50.75
	79170ST	Natural	100/Rack	10 x 100	37.50
Large Orifice - Extra-Long (for maximum reach)					
	79180C2	Natural	Bulk	1000	23.00
	79180G8	Natural	Racked	10 x 100	46.00
	79181G8	Natural	Sterile Racked	10 x 100	51.00
Large Orifice - FILTERED - Extra-Long for full 1000 µl capacity					
	7985105	Natural	Ind. Wrapped, Sterile	1000	19.15
	79851G8	Natural	Sterile Racked	10 x 100	137.60

1000 µl tip Volume 101-1000 µl

Use with Eppendorf®, Titertek® & Socorex

Also for use with: Biohit Proline®, Labpette™, SMI, Jencons Sealpette®, Nichiryo, Oxford-Benchmate®

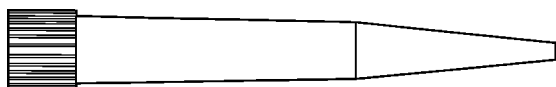

Regular	<u>Catalog No.</u>	<u>Color</u>	<u>Package Type</u>	<u>Quantity</u>	<u>Price</u>
	79742C2	Natural	Bulk	1000	\$22.35
	79742G8	Natural	Racked	10 x 100	45.35
	79744G8	Natural	Sterile Racked	10 x 100	50.75
StackRack	79742ST	Natural	100/Rack	10 x 100	37.50

FILTERED

500 µl and 1000 µl capacity filter tips are special extra-long versions of the 1000 µl tip



350 µl capacity	<u>Catalog No.</u>	<u>Color</u>	<u>Package Type</u>	<u>Quantity</u>	<u>Price</u>
	7986105	Natural	Ind.Wrapped, Sterile	1000	19.15
	79861G8	Natural	Sterile Racked	10 x 100	137.60

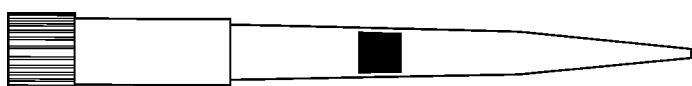

500 µl capacity	<u>Catalog No.</u>	<u>Color</u>	<u>Package Type</u>	<u>Quantity</u>	<u>Price</u>
	7986205	Natural	Ind.Wrapped, Sterile	1000	19.15
	79862G8	Natural	Sterile Racked	10 x 100	137.60

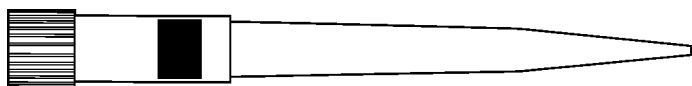

1000 µl capacity	<u>Catalog No.</u>	<u>Color</u>	<u>Package Type</u>	<u>Quantity</u>	<u>Price</u>
	7986305	Natural	Ind.Wrapped, Sterile	1000	19.15
	79863G8	Natural	Sterile Racked	10 x 100	137.60



BLACK Conductive	<u>Catalog No.</u>	<u>Color</u>	<u>Package Type</u>	<u>Quantity</u>	<u>Price</u>
	BK79742C2	Black	Bulk	1000	39.50
	BK79742G8*	Black	HD Racked	10 x 100	62.75
	BK79744G8*	Black	Sterile HD Racked	10 x 100	68.00

*Available with optional HD rack - add HD prefix and \$5 to price.

ROBOTIC TIPS

- Custom-designed to work perfectly with the indicated brands.
- Large selection! Special rigid racks ensure reliability and accurate dispensing.
- Robot-compatible (large micron) hydrophobic filters.
- ALL **Titertek**[®] filtered tips are certified RNase, DNase, pyrogen-free and metal-free.



Zymark[®] Automation Certified[®] Tempo[™] Pipette Tips by QSP[®]

This is the **ONLY** tip and rack system recommended by Zymark[®]

Use with Zymark[®] RapidPlate[®] 96 and RapidPlate[®] 96/ 384, also for Presto[®], Sciclone[®], and TekCel[®]

Regular 100 µl

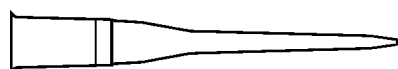

<u>Zymark#</u>	<u>Catalog No.</u>	<u>Color</u>	<u>Package Type</u>	<u>Quantity</u>	<u>Price</u>
68037	80100C2	Natural	Bulk	1000	\$23.00
66670	80100H2	Natural	Racked	10 x 96	46.50
68036	80101H2	Natural	Sterile Racked	10 x 96	51.00

FILTERED (80 µl capacity)

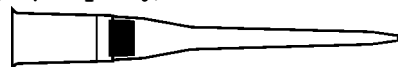

68759	80102H2	Natural	Sterile Racked	10 x 96	120.00
-------	----------------	---------	----------------	---------	--------

Conductive 100 µl



68892	BK80100H2	Black	Racked	10 x 96	73.50
68924	BK80101H2	Black	Sterile Racked	10 x 96	82.00

Conductive & FILTERED (80 µl capacity)



72308	BK80102H2	Black	Sterile Racked	10 x 96	135.00
-------	------------------	-------	----------------	---------	--------

Regular 200 µl

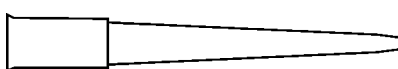

<u>Zymark#</u>	<u>Catalog No.</u>	<u>Color</u>	<u>Package Type</u>	<u>Quantity</u>	<u>Price</u>
57203	80110C2	Natural	Bulk	1000	23.00
56362	80110H2	Natural	Racked	10 x 96	46.50
56977	80111H2	Natural	Sterile Racked	10 x 96	51.00

FILTERED (150 µl capacity)

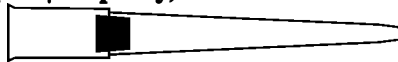

68921	80112H2	Natural	Sterile Racked	10 x 96	120.00
-------	----------------	---------	----------------	---------	--------

Conductive 200 µl



65408	BK80110H2	Black	Racked	10 x 96	73.50
68891	BK80111H2	Black	Sterile Racked	10 x 96	82.00

Conductive & FILTERED (150 µl capacity)



72309	BK80112H2	Black	Sterile Racked	10 x 96	135.00
-------	------------------	-------	----------------	---------	--------

1000 µl (Blue)

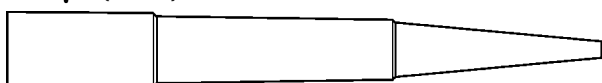





<u>Catalog No.</u>	<u>Color</u>	<u>Package Type</u>	<u>Quantity</u>	<u>Price</u>
80120C2	Blue	Bulk	1000	12.50
80120H2	Blue	Racked	10 x 96	48.00
80121H2	Blue	Sterile Racked	10 x 96	53.50

ROBOTIC TIPS





- Large selection!
- Special rigid racks ensure reliability and accurate dispensing.
- Robot-compatible (large micron) hydrophobic filters.
- ALL **Titertek**[®] filtered tips are certified RNase, DNase, pyrogen-free and metal-free

For Beckman[®] Biomek[®] 1000/2000

	<u>Catalog No.</u>	<u>Color</u>	<u>Package Type</u>	<u>Quantity</u>	<u>Price</u>
Regular 20 µl					
	80200C2	Natural	Bulk	1000	\$20.00
	80200H2	Natural	Racked	10 x 96	50.00
	80201H2	Natural	Sterile Racked	10 x 96	55.00
FILTERED (20 µl capacity)					
	80202H2	Natural	Sterile Racked	10 x 96	120.00
Conductive 20 µl					
	BK80200H2	Black	Racked	10 x 96	75.00
	BK80201H2	Black	Sterile Racked	10 x 96	84.00
Conductive & FILTERED (20 µl capacity)					
	BK80202H2	Black	Sterile Racked	10 x 96	140.00

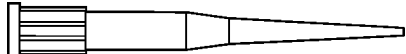
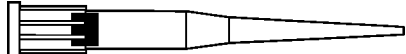
For Beckman[®] Biomek[®] 1000/2000 and for use with: Packard MultiPROBE™

	<u>Catalog No.</u>	<u>Color</u>	<u>Package Type</u>	<u>Quantity</u>	<u>Price</u>
Regular 250 µl					
	80210C2	Natural	Bulk	1000	20.00
	80210H2	Natural	Racked	10 x 96	50.00
	80211H2	Natural	Sterile Racked	10 x 96	55.00
FILTERED (180 µl capacity)					
	80212H2	Natural	Sterile Racked	10 x 96	120.00
Conductive 250 µl					
	BK80210H2	Black	Racked	10 x 96	75.00
	BK80211H2	Black	Sterile Racked	10 x 96	84.00
Conductive & FILTERED (180 µl capacity)					
	BK80212H2	Black	Sterile Racked	10 x 96	140.00

ROBOTIC TIPS

For Tecan Genesis Automation

20 µl and 50 µl sizes

Regular 20 µl



<u>Catalog No.</u>	<u>Color</u>	<u>Package Type</u>	<u>Quantity</u>	<u>Price</u>
80300C2	Natural	Bulk	1000	\$45.00
80300H2	Natural	Racked	10 x 96	92.00
80301H2	Natural	Sterile Racked	10 x 96	104.00

FILTERED (10 µl capacity)



80302H2	Natural	Sterile Racked	10 x 96	144.00
----------------	---------	----------------	---------	--------

Conductive



BK80300H2	Black	Racked	10 x 96	130.00
BK80301H2	Black	Sterile Racked	10 x 96	146.00

Conductive/FILTERED (10 µl capacity)



BK80302H2	Black	Sterile Racked	10 x 96	189.00
------------------	-------	----------------	---------	--------

Regular 50 µl

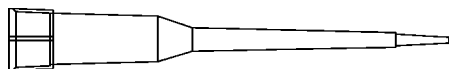

<u>Catalog No.</u>	<u>Color</u>	<u>Package Type</u>	<u>Quantity</u>	<u>Price</u>
80310C2	Natural	Bulk	1000	47.00
80310H2	Natural	Racked	10 x 96	96.00
80311H2	Natural	Sterile Racked	10 x 96	109.00

FILTERED 50 µl

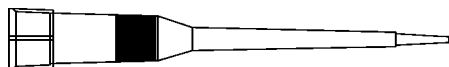

80312H2	Natural	Sterile Racked	10 x 96	149.00
----------------	---------	----------------	---------	--------

Conductive 50 µl



BK80310H2	Black	Racked	10 x 96	135.00
BK80311H2	Black	Sterile Racked	10 x 96	151.00

Conductive/Filtered (50 µl capacity)



BK80312H2	Black	Sterile Racked	10 x 96	194.00
------------------	-------	----------------	---------	--------

ROBOTIC TIPS

For Tecan Genesis Automation

200 µl and 1000 µl sizes

Regular 200 µl

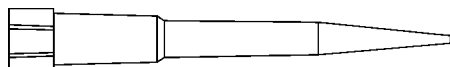

Catalog No.	Color	Package Type	Quantity	Price
80320C2	Natural	Bulk	1000	\$46.00
80320H2	Natural	Racked	10 x 96	92.00
80321H2	Natural	Sterile Racked	10 x 96	105.00

FILTERED (200 µl capacity)

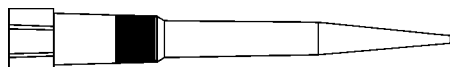

80322H2	Natural	Sterile Racked	10 x 96	144.00
----------------	---------	----------------	---------	--------

Conductive



BK80320H2	Black	Racked	10 x 96	130.00
BK80321H2	Black	Sterile Racked	10 x 96	146.00

Conductive/FILTERED (200 µl capacity)



BK80322H2	Black	Sterile Racked	10 x 96	189.00
------------------	-------	----------------	---------	--------

Regular 1000 µl

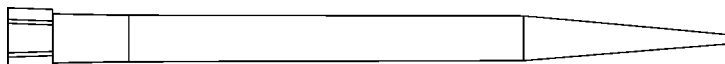

80330C2	Natural	Bulk	1000	50.00
80330H2	Natural	Racked	10 x 96	100.00
80331H2	Natural	Sterile Racked	10 x 96	111.00

FILTERED (1000 µl capacity)

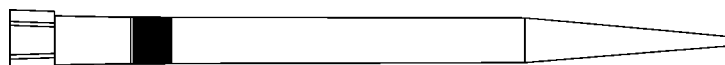

80332H2	Natural	Sterile Racked	10 x 96	149.00
----------------	---------	----------------	---------	--------

Conductive



BK80330H2	Black	Racked	10 x 96	140.00
BK80331H2	Black	Sterile Racked	10 x 96	157.00

Conductive & FILTERED (1000 µl capacity)







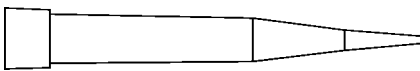
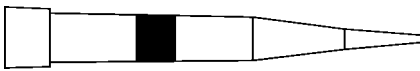

BK80332H2	Black	Sterile Racked	10 x 96	200.00
------------------	-------	----------------	---------	--------

ROBOTIC TIPS

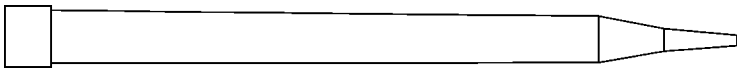
For Qiagen Automation

300 µl and 1100 µl sizes

	<u>Catalog No.</u>	<u>Color</u>	<u>Package Type</u>	<u>Quantity</u>	<u>Price</u>
Regular 300 µl 	80400C2	Natural	Bulk	1000	\$47.50
	80400H2	Natural	Racked	10 x 96	96.00
	80401H2	Natural	Sterile Racked	10 x 96	111.00
FILTERED (300 µl capacity) 	80402H2	Natural	Sterile Racked	10 x 96	149.00
Conductive 300 µl 	BK80400H2	Black	Racked	10 x 96	135.00
	BK80401H2	Black	Sterile Racked	10 x 96	157.00
Conductive & FILTERED (300 µl capacity) 	BK80402H2	Black	Sterile Racked	10 x 96	195.00
Regular 1100 µl 	80410C2	Natural	Bulk	1000	53.00
	80410H2	Natural	Racked	10 x 96	108.00
	80411H2	Natural	Sterile Racked	10 x 96	123.00
FILTERED (1100 µl capacity) 	80412H2	Natural	Sterile Racked	10 x 96	165.00
Conductive 1100 µl 	BK80410H2	Black	Racked	10 x 96	151.00
	BK80411H2	Black	Sterile Racked	10 x 96	173.00
Conductive & FILTERED (1100 µl capacity) 	BK80412H2	Black	Sterile Racked	10 x 96	215.00

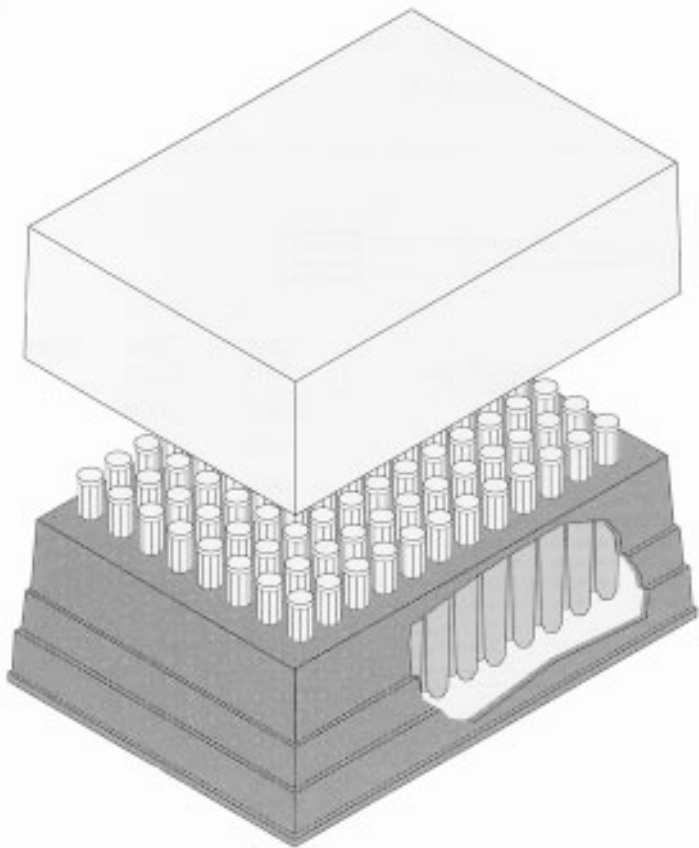

Automatic liquid handling systems rely on force, which can cause flexing in the rack and improper seating of the tips. Titertek®'s QSP® brand "robotic compatible rack" is specifically designed to withstand extreme force, ensuring reliable attachment of all the tips in the rack. Individual interior rack compartments isolate each tip, to eliminate the possibility of cross-contamination. Standard with all ROBOTIC tips from ICN.

Titertek® pipette tips are manufactured of virgin, non-wettable polypropylene material to reduce fluid retention and optimize instrument performance. Robot-compatible (large-Micron) hydrophobic filters effectively eliminate instrument contamination caused by aerosol formulation during pipetting procedures. All presterilized Titertek® filter tips are certified RNase-free, DNase-free, pyrogen-free, and trace metal-free.

TRADEMARK ACKNOWLEDGEMENTS

Automation Certified®	Zymark Corporation	MLA®	Medical Lab. Automation, Inc.
BBL®	Becton Dickinson & Co.	Oxford®	Sherwood Medical Company
Beckman®	Beckman Instrument Co.	PCR (Polymerase Chain Reaction)	PCR process is covered by patents owned by Hoffman-LaRoche, Inc.
Benchmate®	Sherwood Medical Co.	Pipetman®	Gilson Medical Electronics S.A.
Biohit Proline®	Biohit OY	Plus/8™	Eppendorf-Netheler-Hinz GmbH
Centrifichem®	Serono-Baker Diagnostics, Inc.	QLS®	POREX Bio Products, Inc.
Clay Adams®	Becton Dickinson & Co.	QSP®	POREX Bio Products, Inc.
Costar®	Data packaging, dba Costar	Rapidplate®	Zymark Corporation
EDOS™	Eppendorf-Netheler-Hinz GmbH	Repeater™	Eppendorf-Netheler-Hinz GmbH
EDP2™	Rainin Instrument Co.	Sara-Pette®	DBM Scientific
EDP-PLUS™	Rainin Instrument Co.	Sealpette®	Jencons Scientific
Eppendorf®	Eppendorf-Netheler-Hinz GmbH	Selectapette®	Becton Dickinson & Co.
8 & 12 Pette®	Costar Corporation	SMAC™	Technicon Instruments Corp.
Fibrometer®	B.D.Laboratories Corporation	Technicon RA-1000®	Technicon instruments Corp.
Finnpipette®	Kommandittiyhtio Finnpipette, Helsinki, Finland	Tempo™	Zymark Corporation
Helena®	Helena Laboratories Corp.	Titertek®, Titertek-Plus®	ICN Biomedicals, Inc.
Hitachi®	Hitachi, Ltd.	Transferpette®	Brinkman
Labpette™	Labnet International, Inc.	Zymark®	Zymark Corporation
Lancer®	Sherwood Medical Co.	Zymark Automation Certified®	Zymark Corporation

WARRANTY AND LIABILITY INFORMATION

ICN warrants its products to be free of defects in material and workmanship. ICN will replace product or issue credit, at its sole option, upon prompt notification and compliance with its instructions. Complete warranty information regarding remedies for any claim arising out of the purchase of any ICN product may be found in the ICN catalog. ICN expressly disclaims all other warranties, whether express, implied or statutory, including the implied warranty of merchantability and fitness for a particular purpose, and further excludes consequential damages arising out of the use of the products herein. Information provided on products in this brochure is correct and reliable to the best of our knowledge at time of publication.



Biomedical Research Products

ONE CALL. ONE SOURCE.

A world of Biomedical products

Orders:

Toll Free: (U.S. and Canada)

Tel: (800) 854-0530

Fax: (800) 334-6999

Outside the U.S. and Canada

Tel: (330) 562-1500

Fax: (330) 562-1987

www.icnbiomed.com

Technical Service:

Tel: (800) 279-5490

Fax: (330) 562-2642

Email: biotech@icnbiomed.com